

la Créole
1/48
Pl. 1



la Créole

1/48

Pl. 2

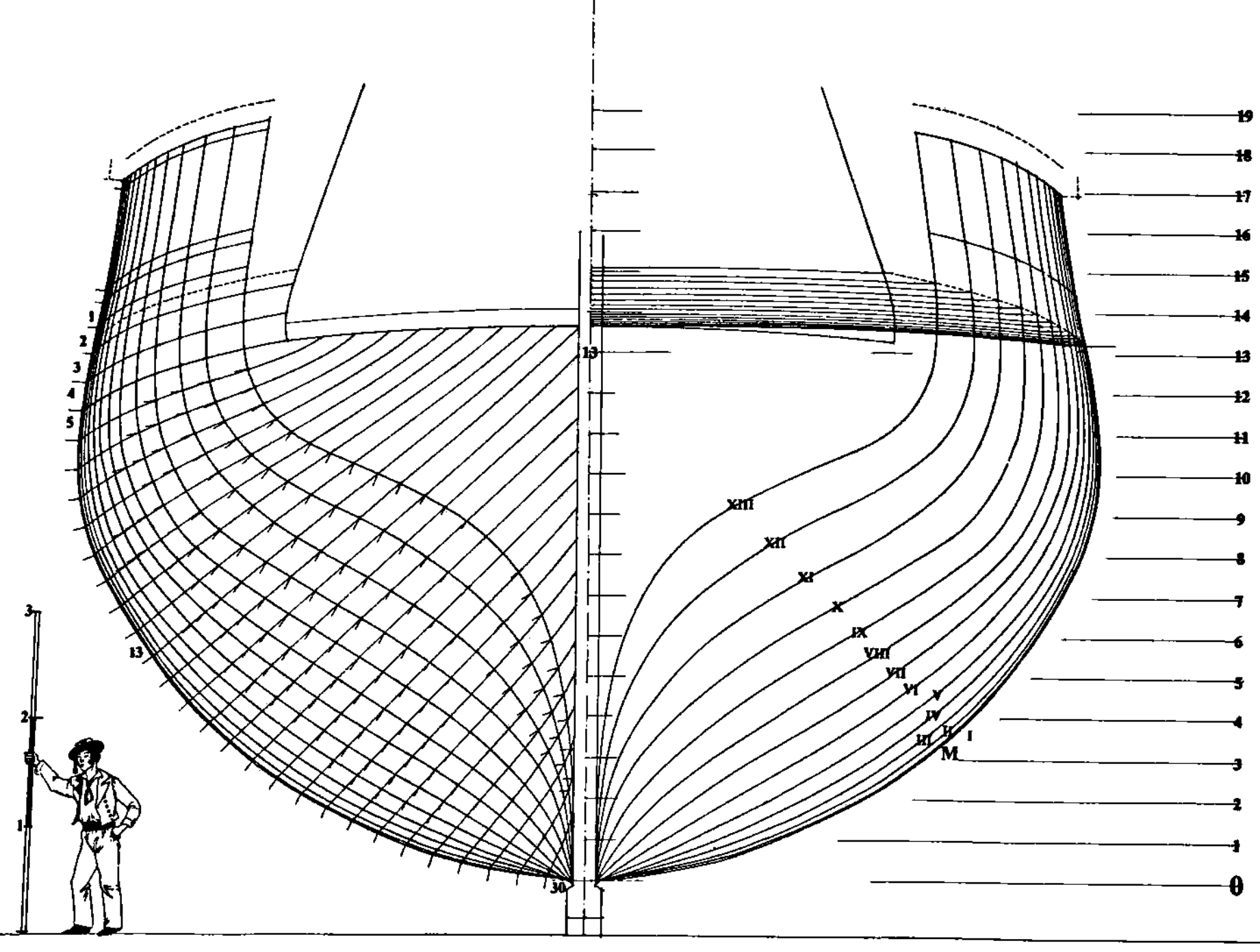
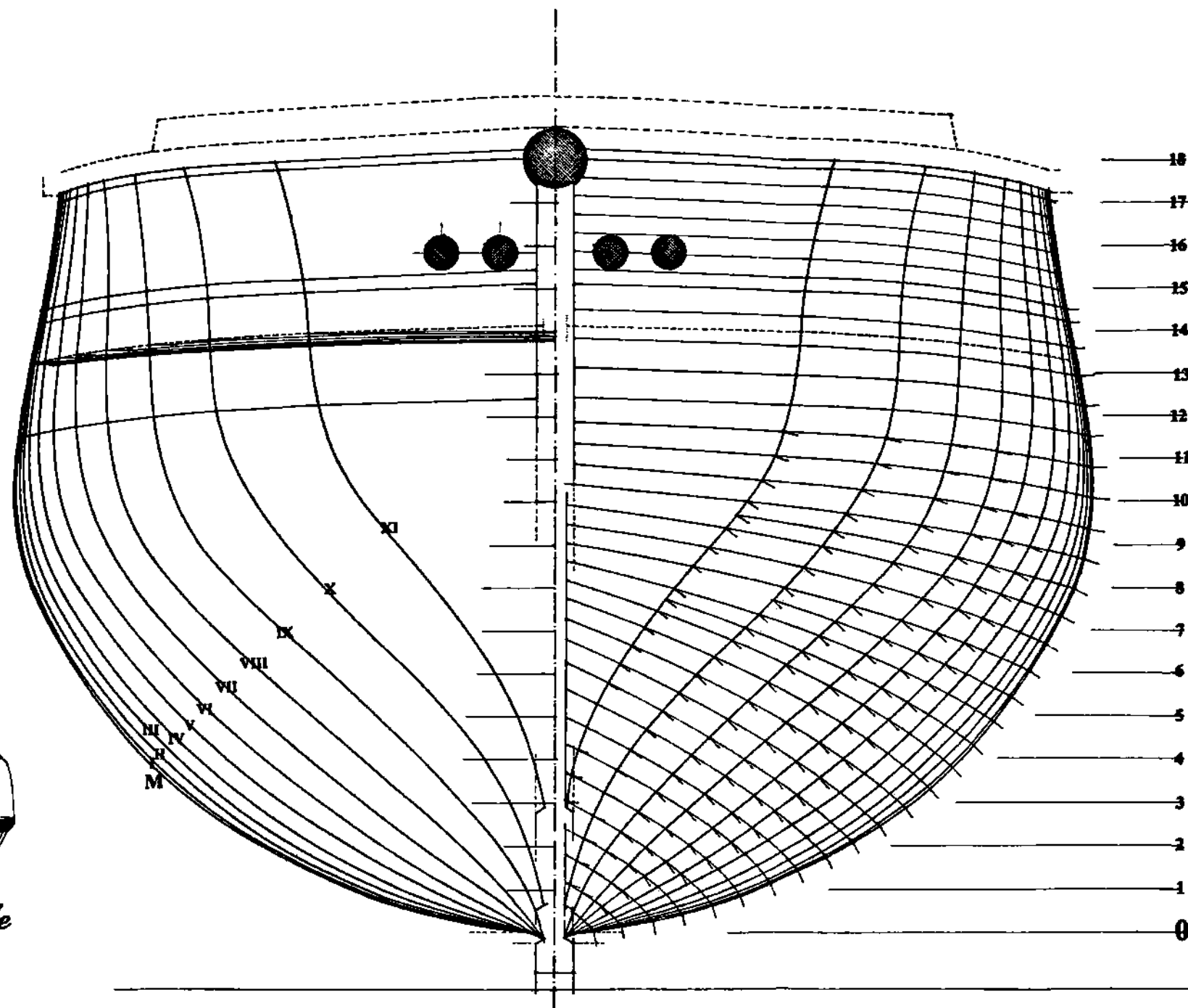

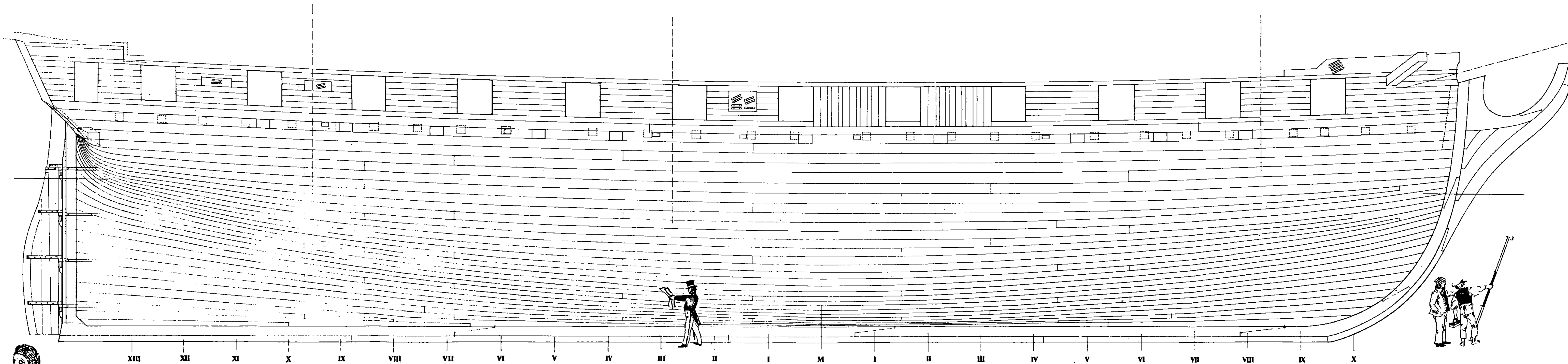

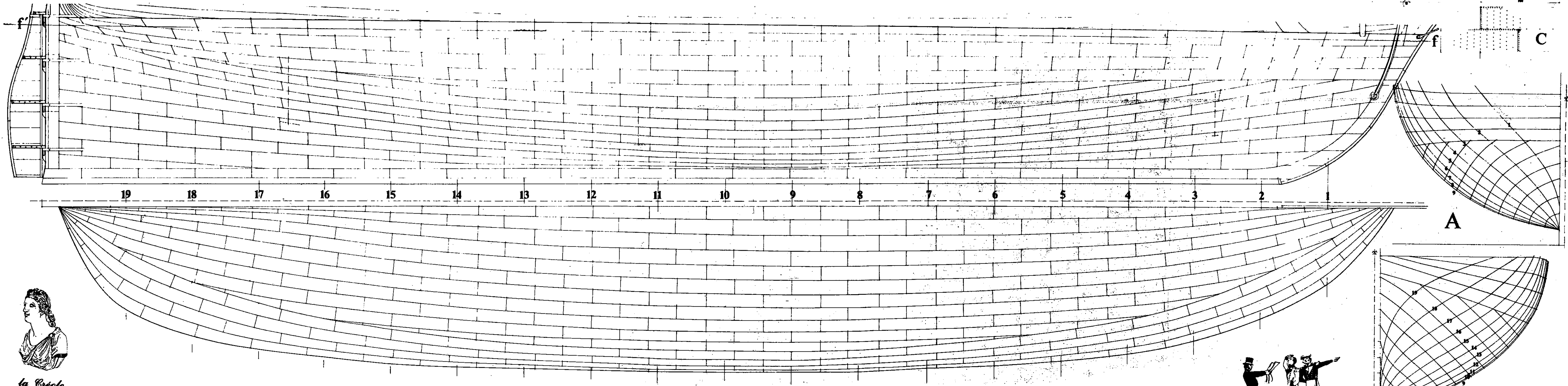

la Créole
1/48
Pl. 4

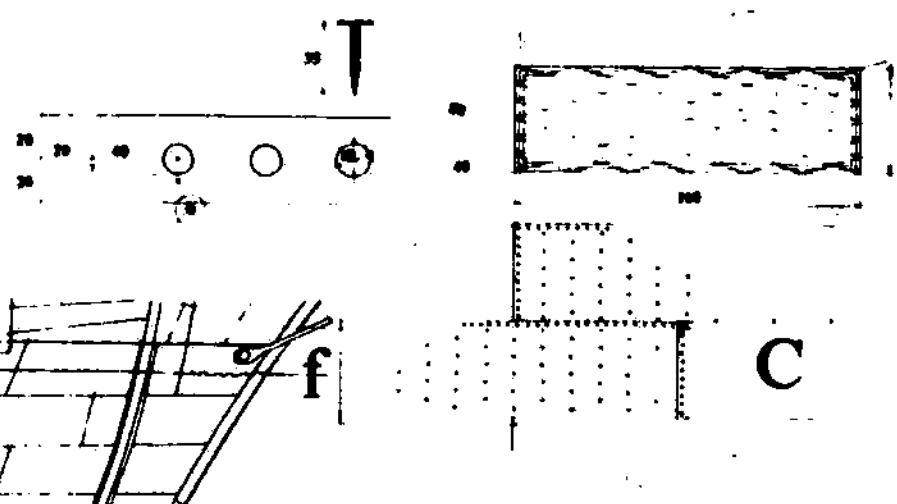
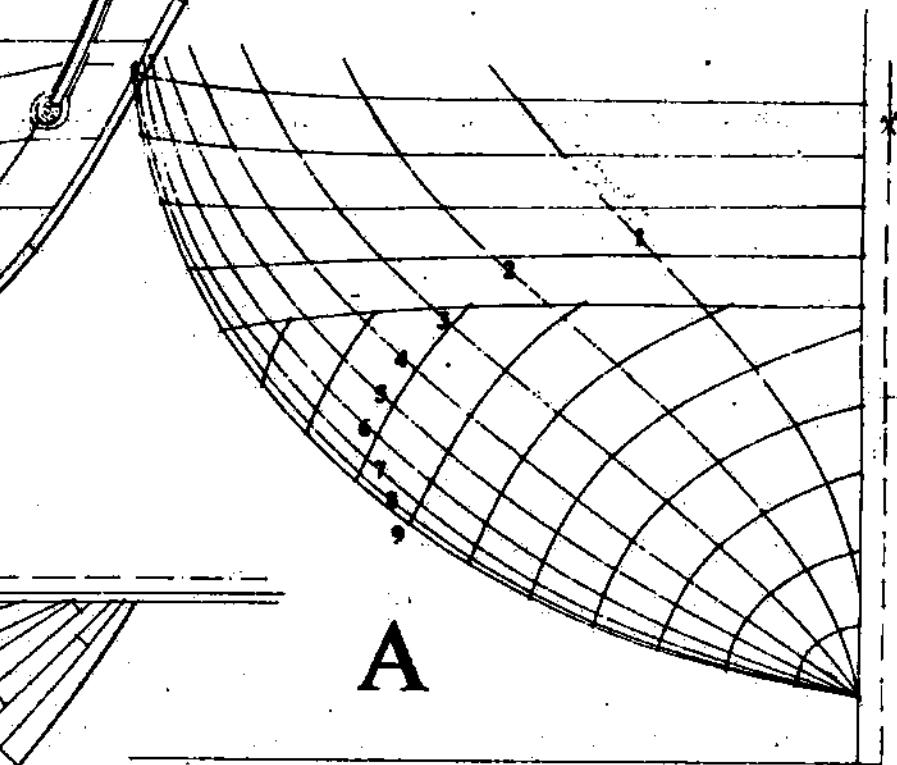
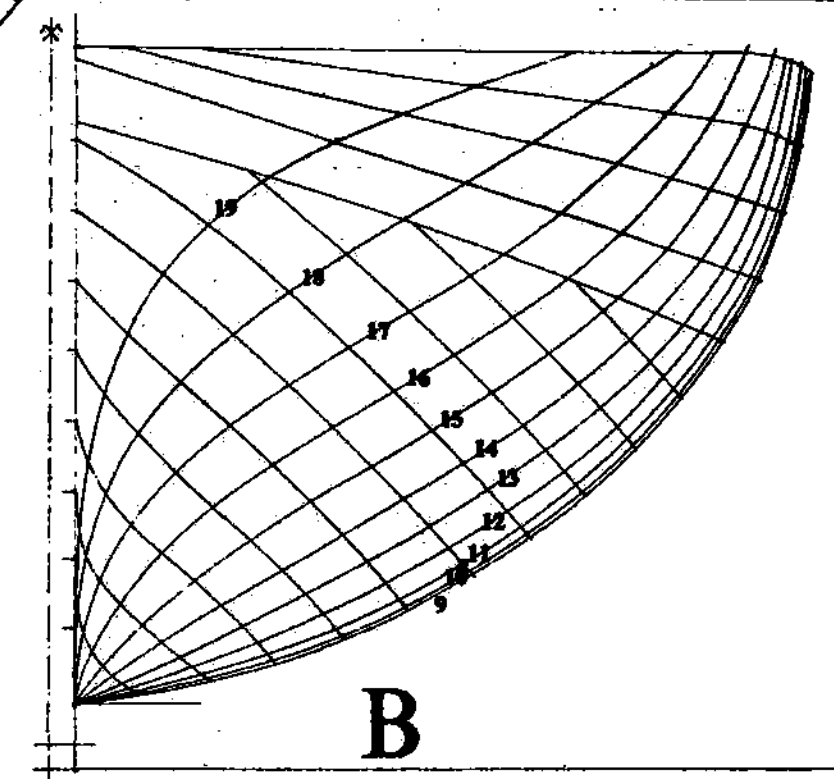

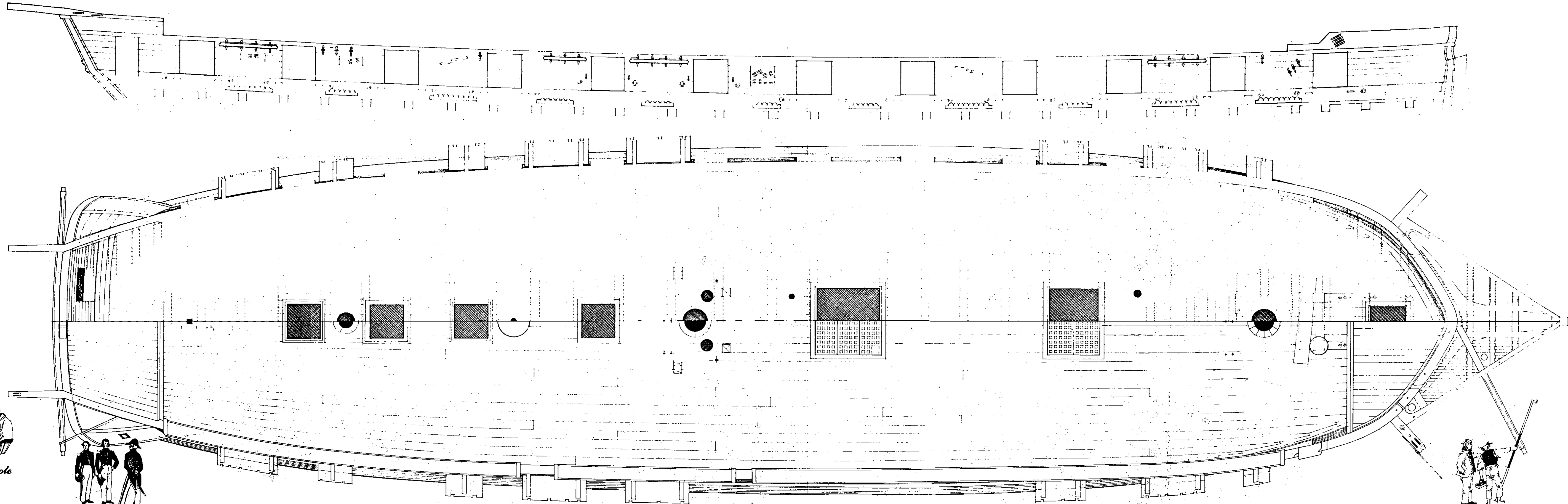

la Créole
1/48
Pl. 5



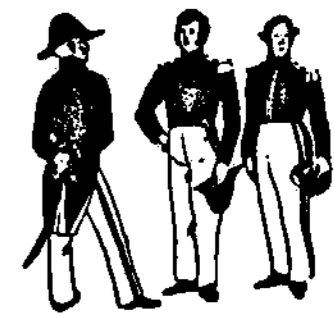
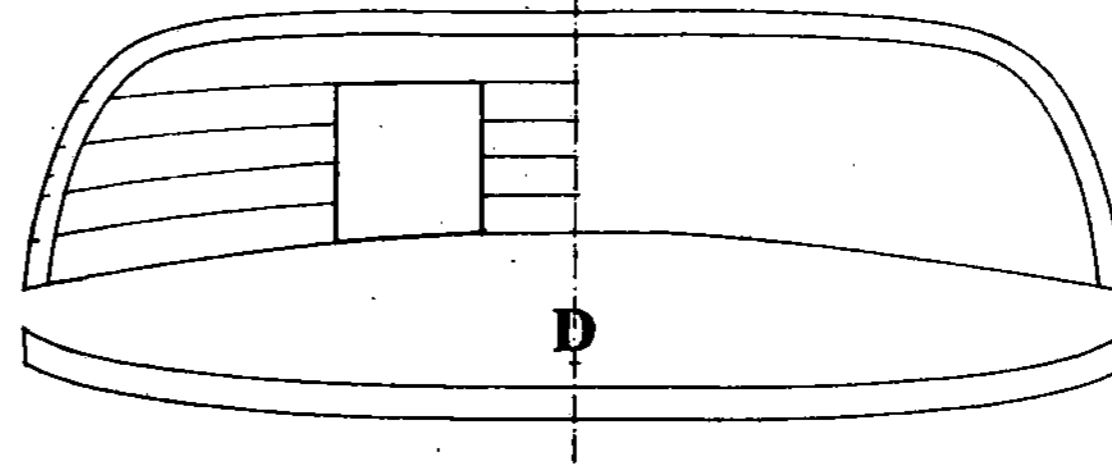
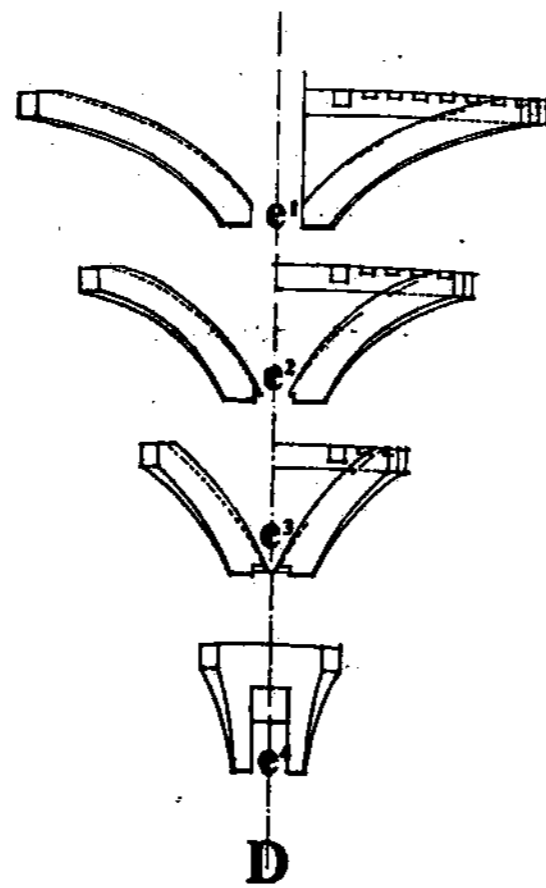
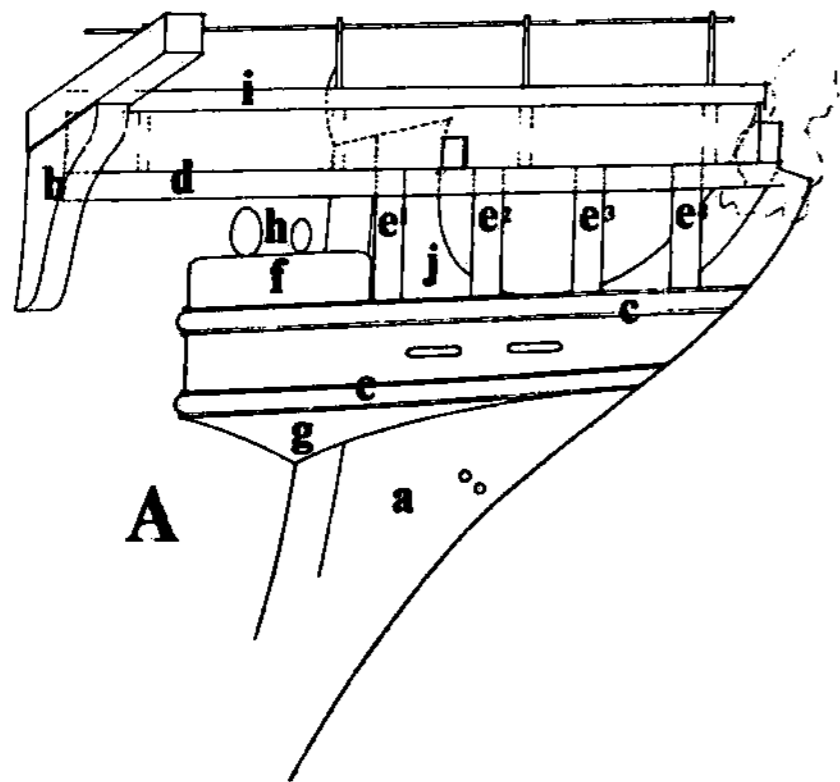
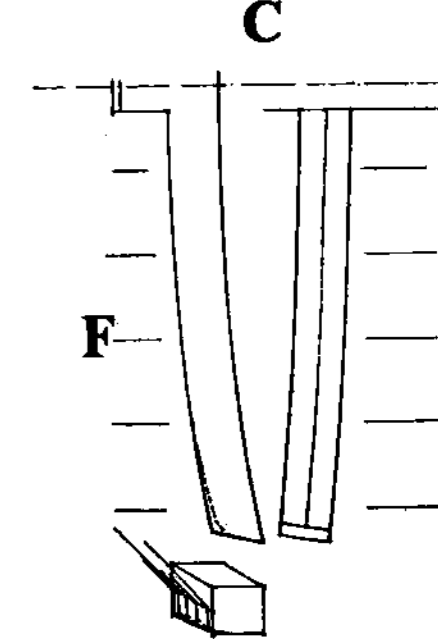
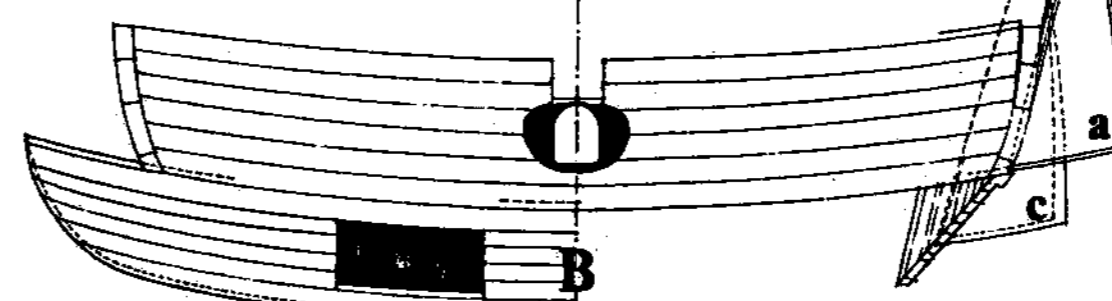
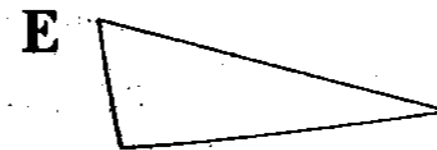
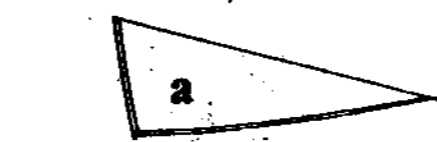
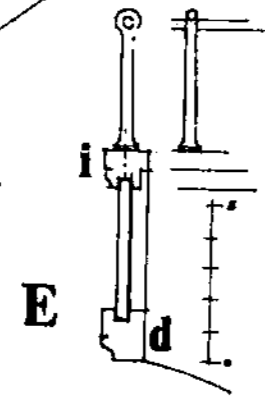
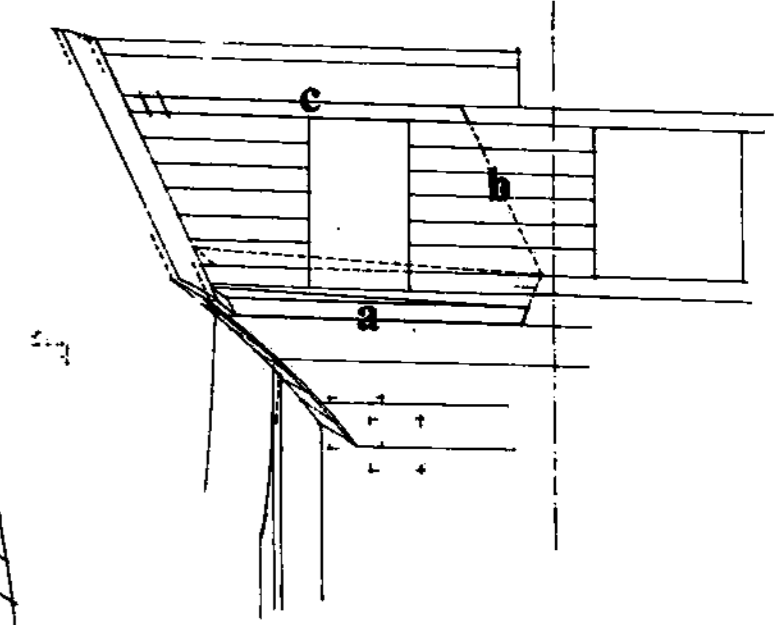
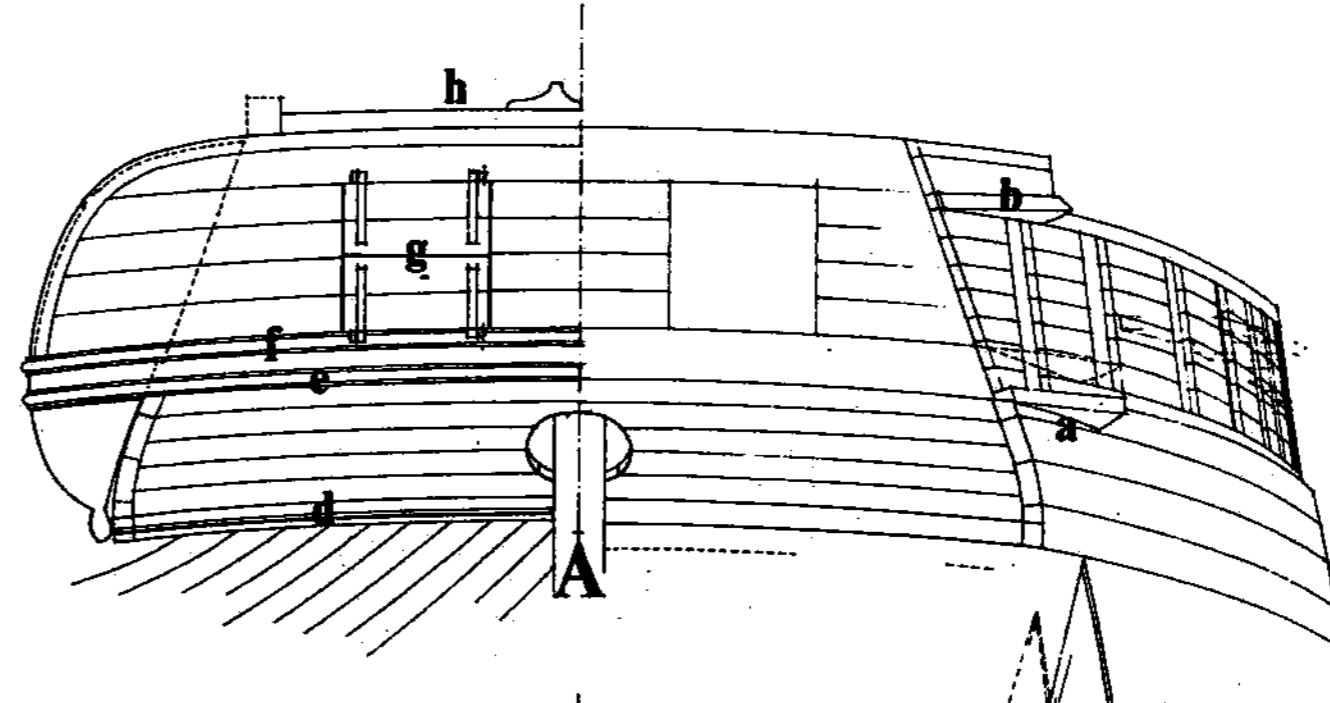
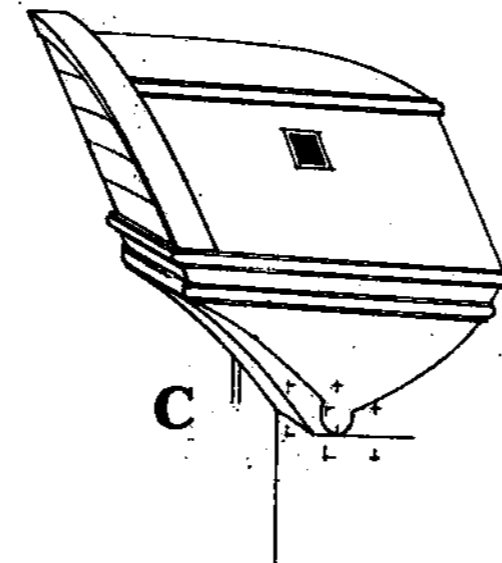
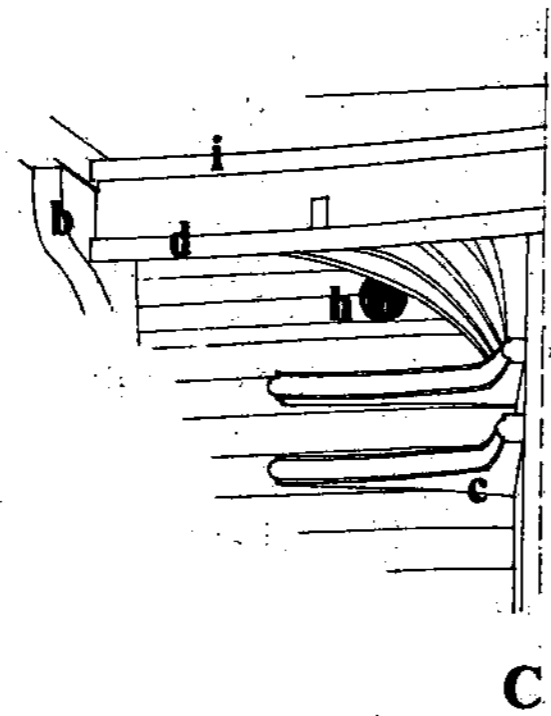
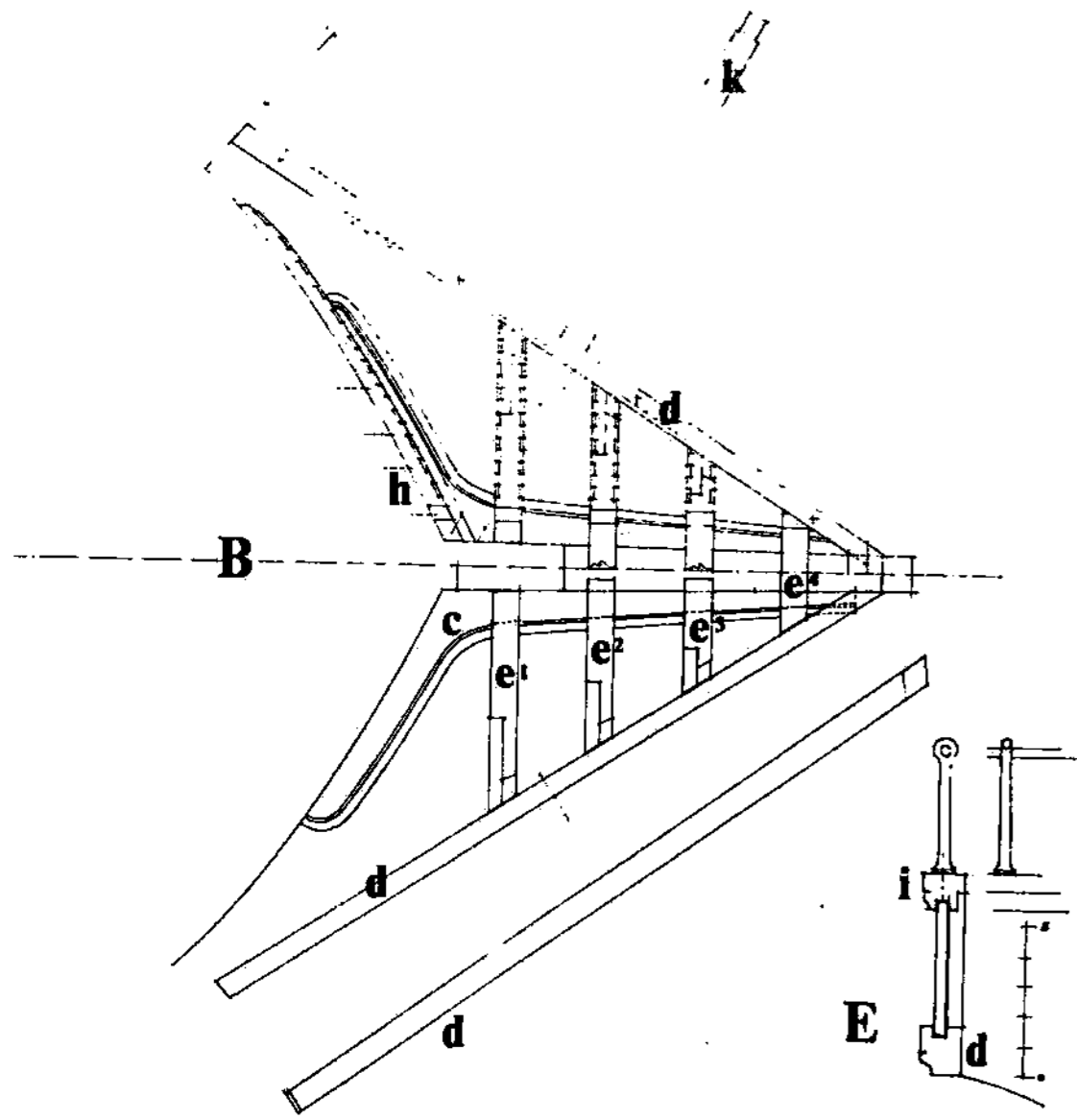

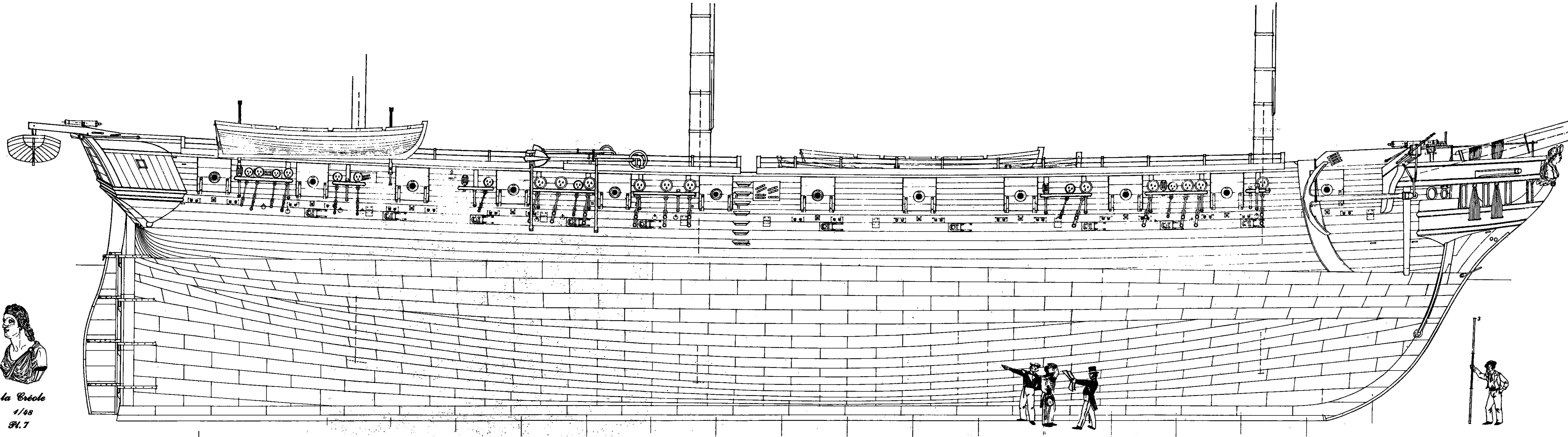

la Créole
1/48
Pl. 7

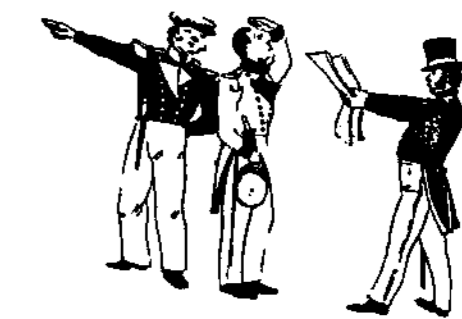
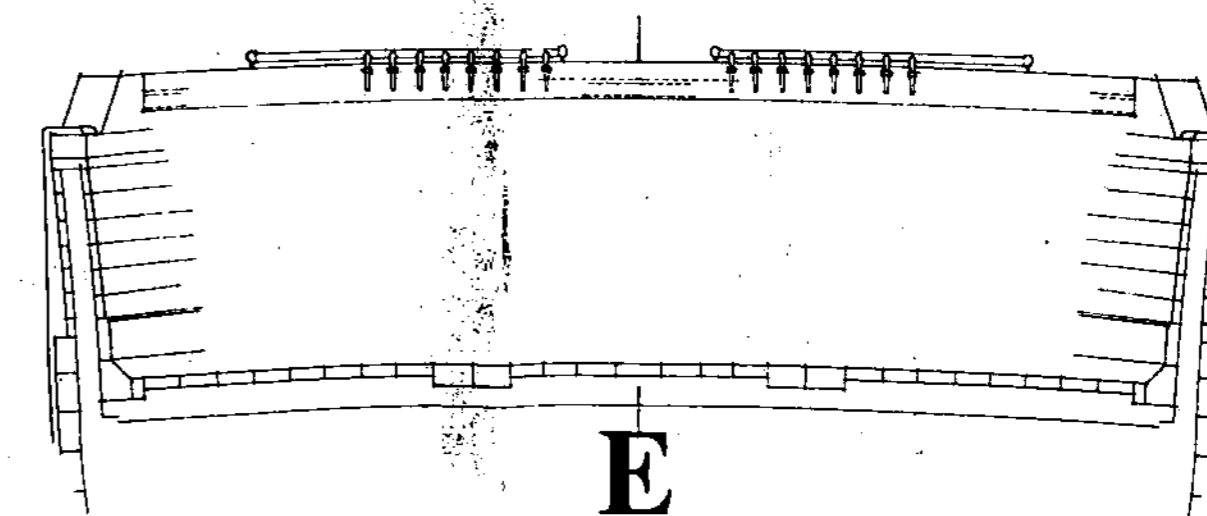
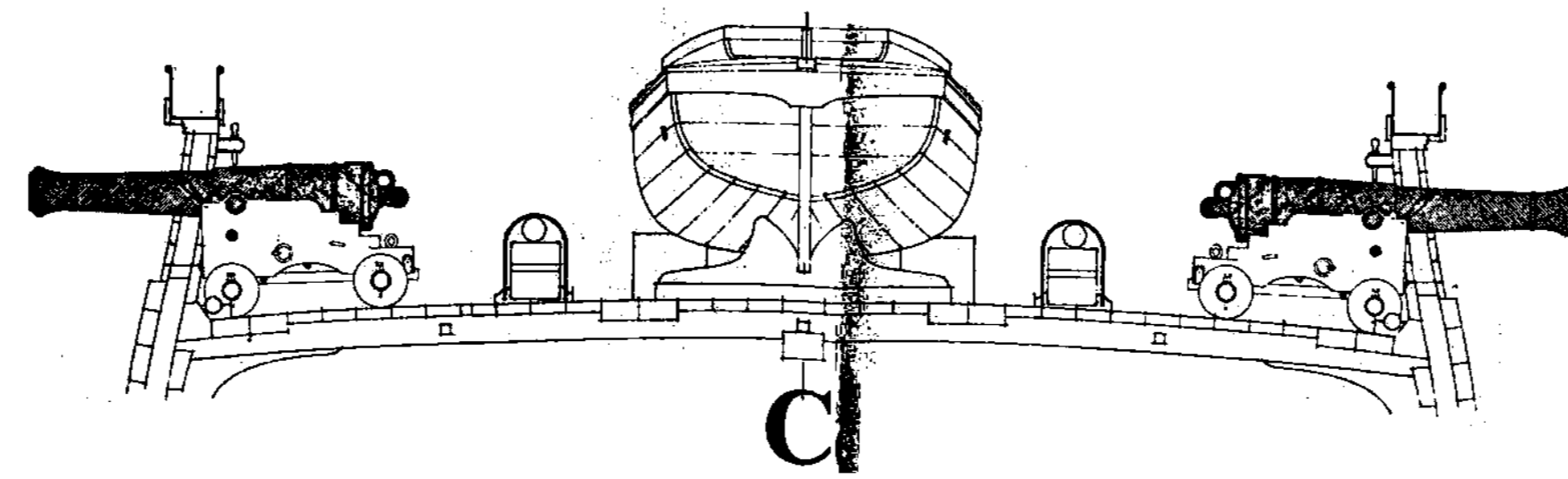
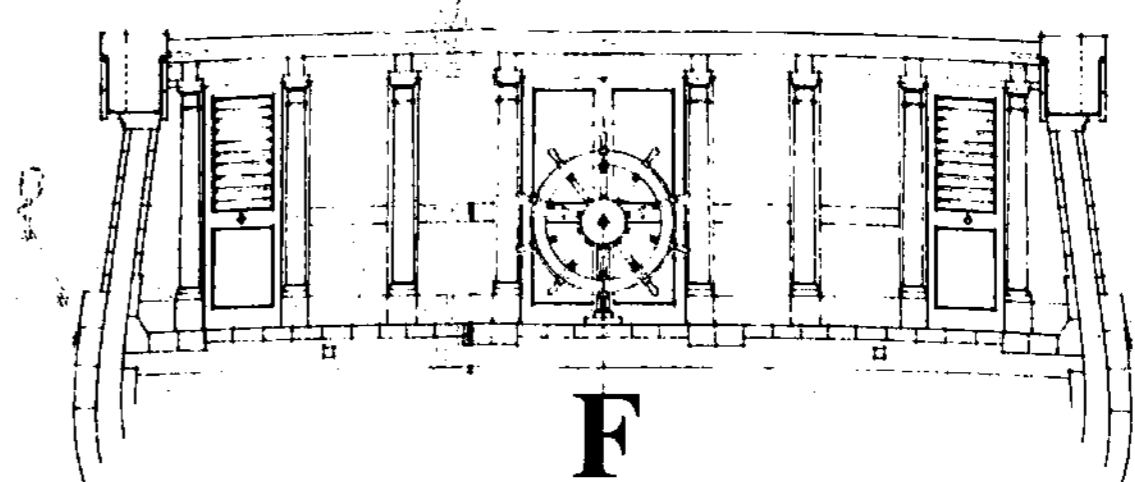
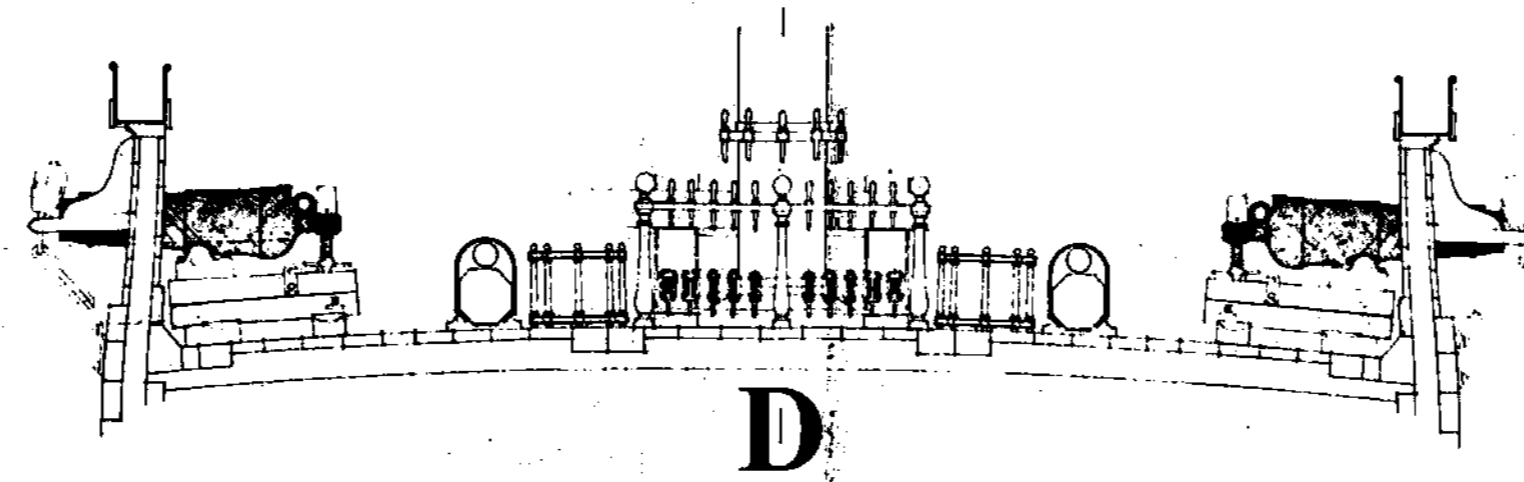
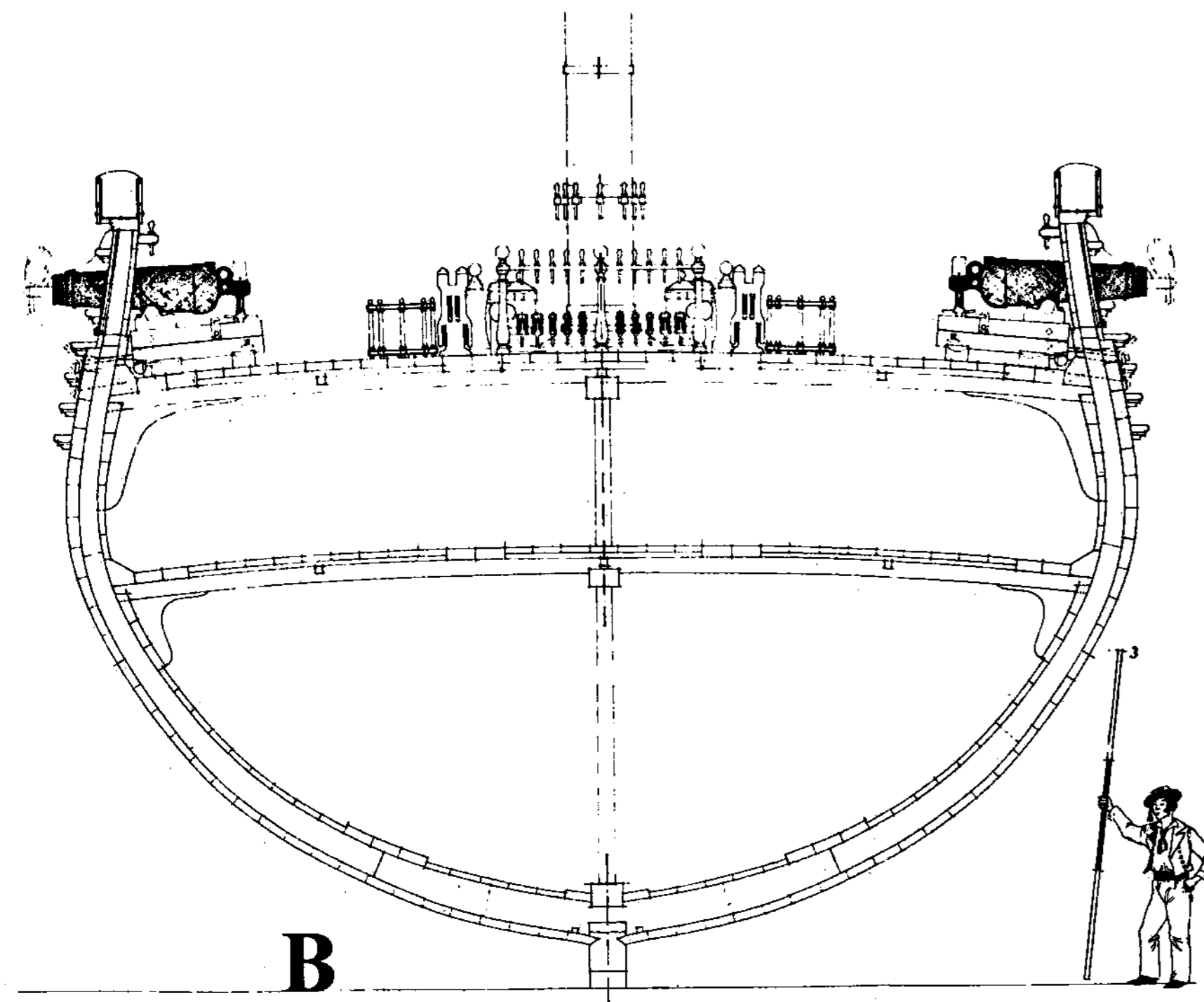
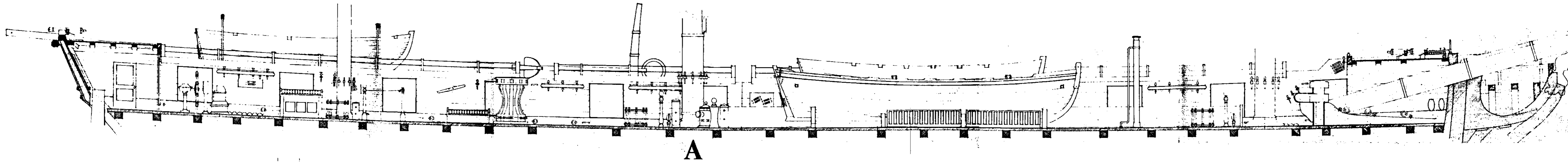

la Créole
1/48
Pl. 8

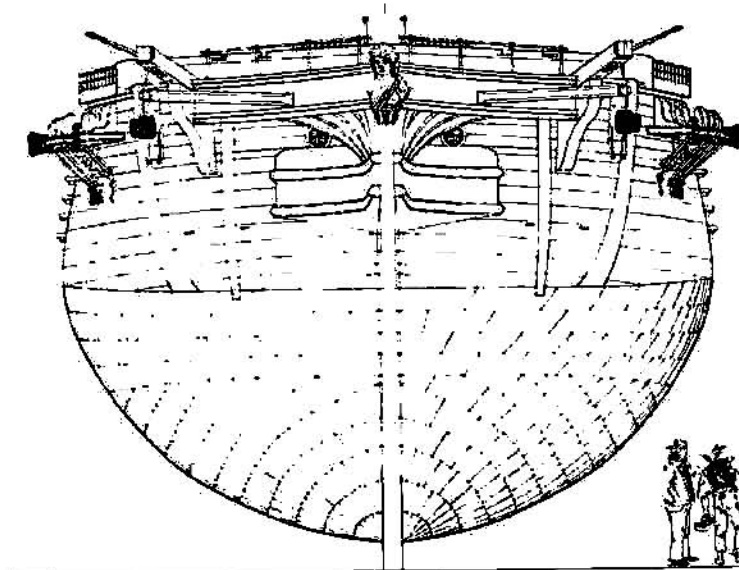

A

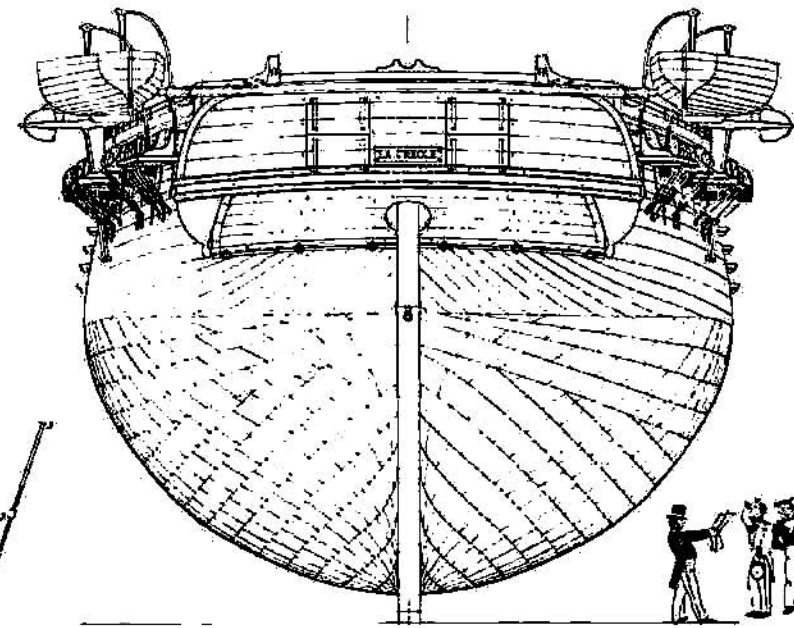

B



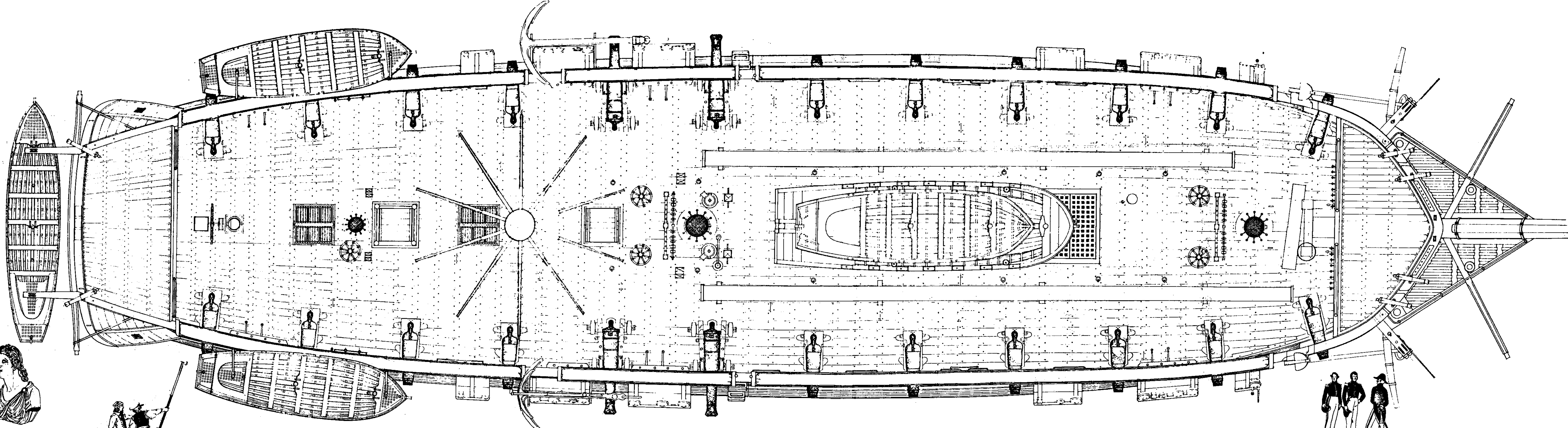

la Créole
1/48
Pl. 10

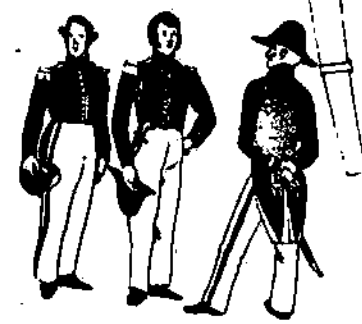

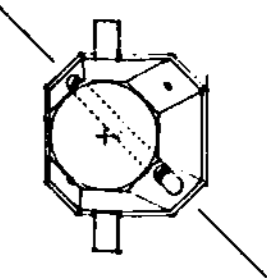
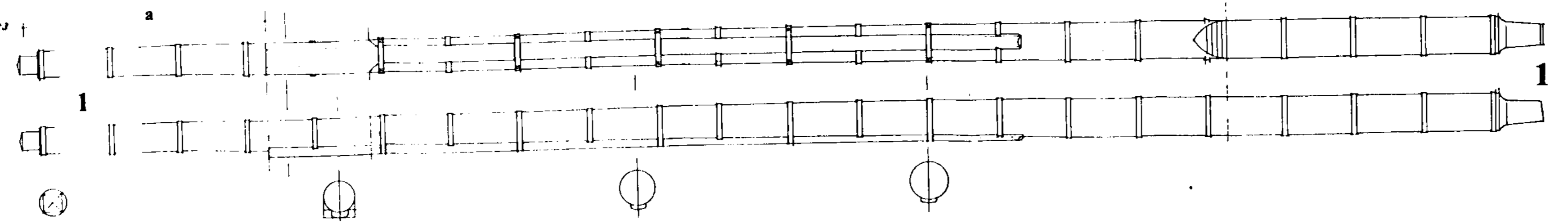
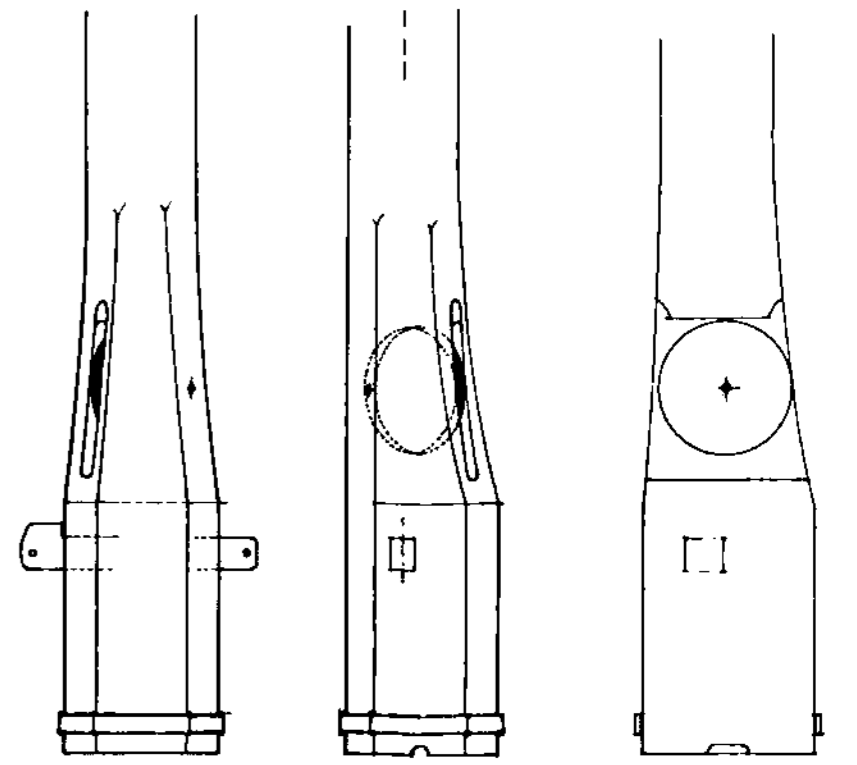
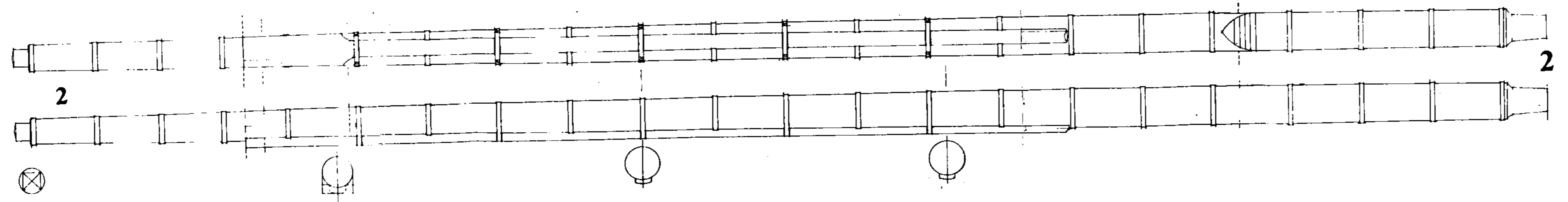
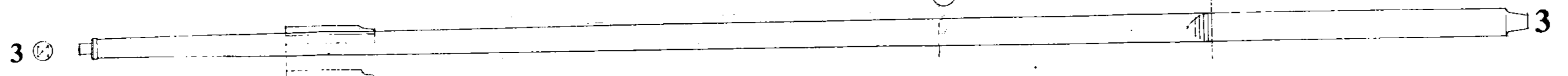
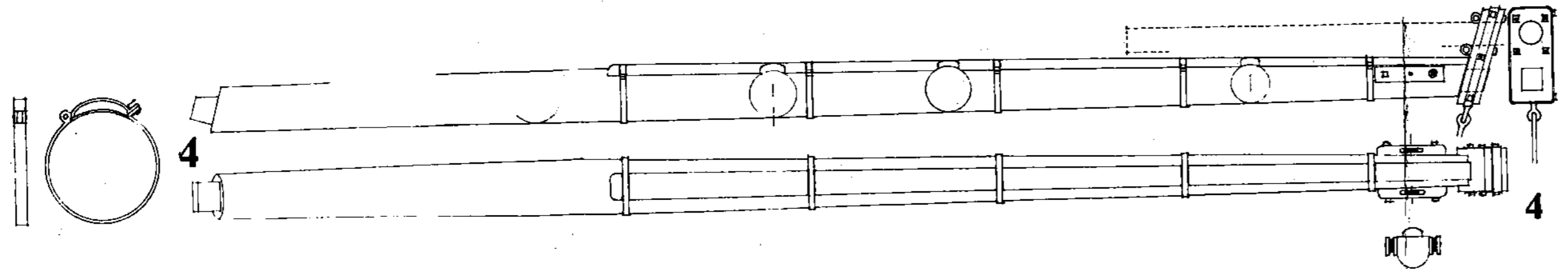
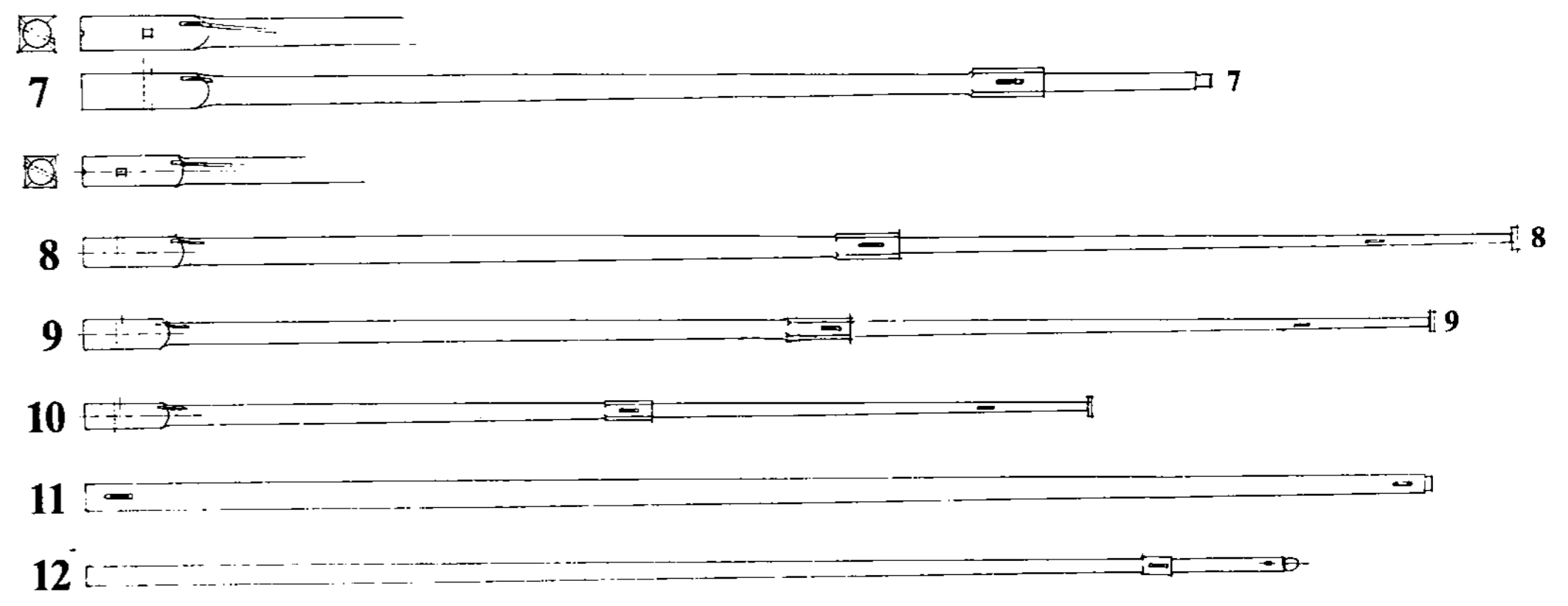
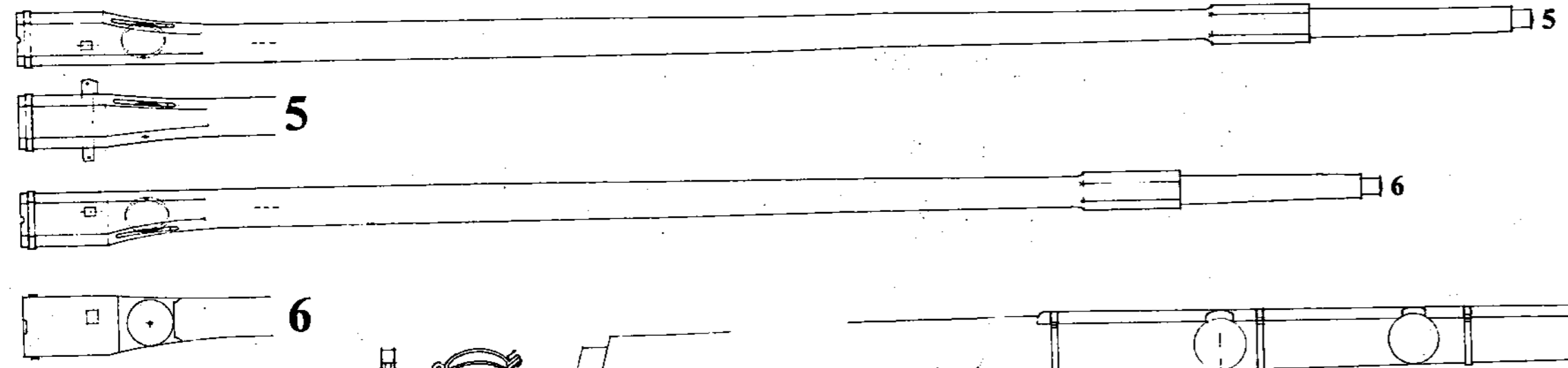
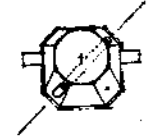

A

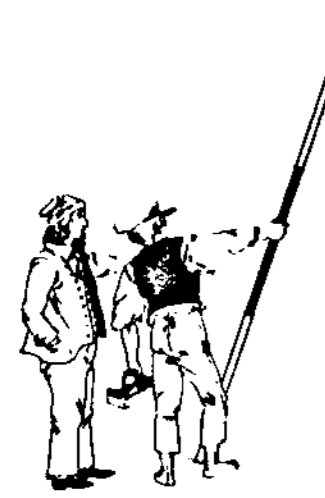

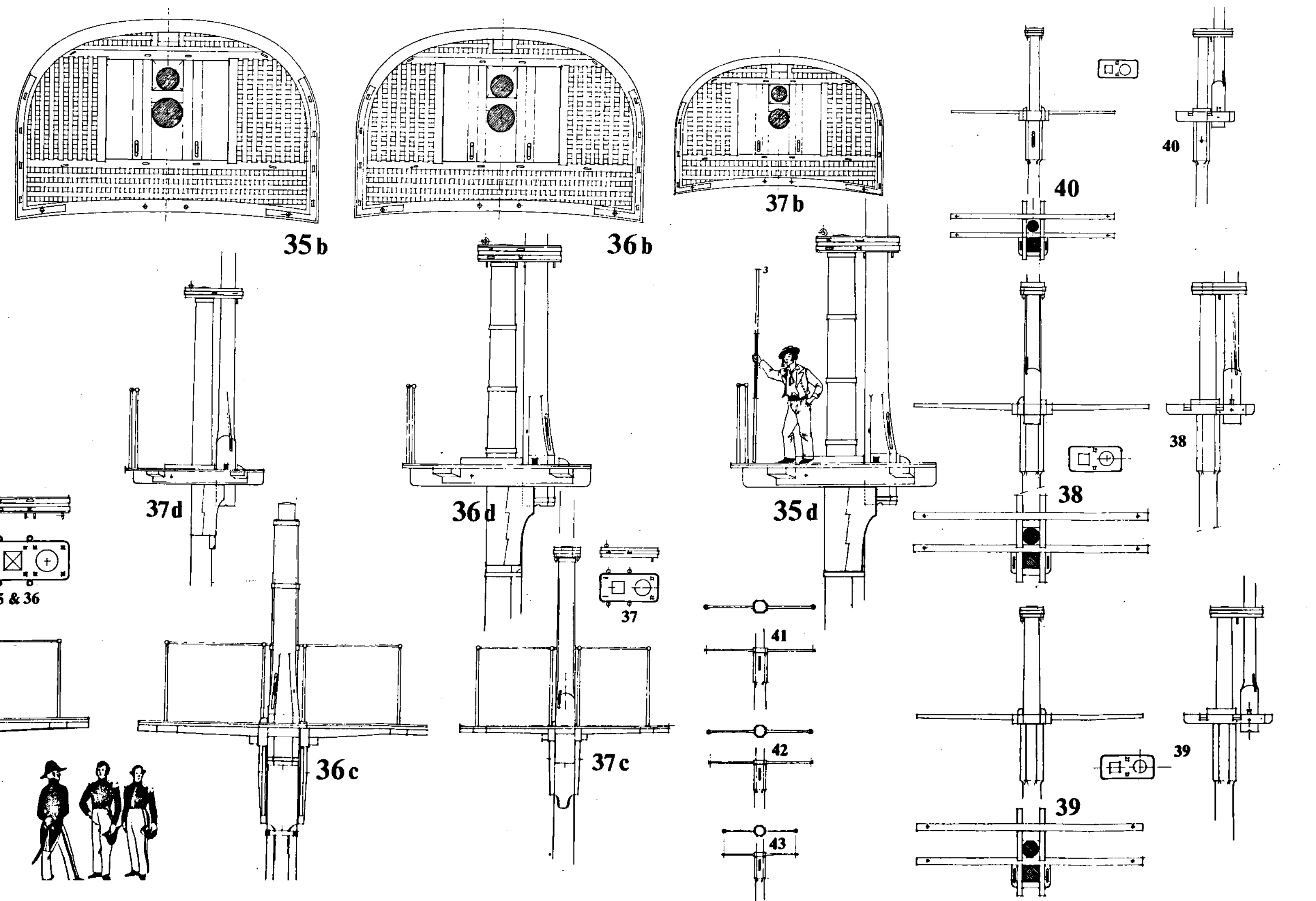
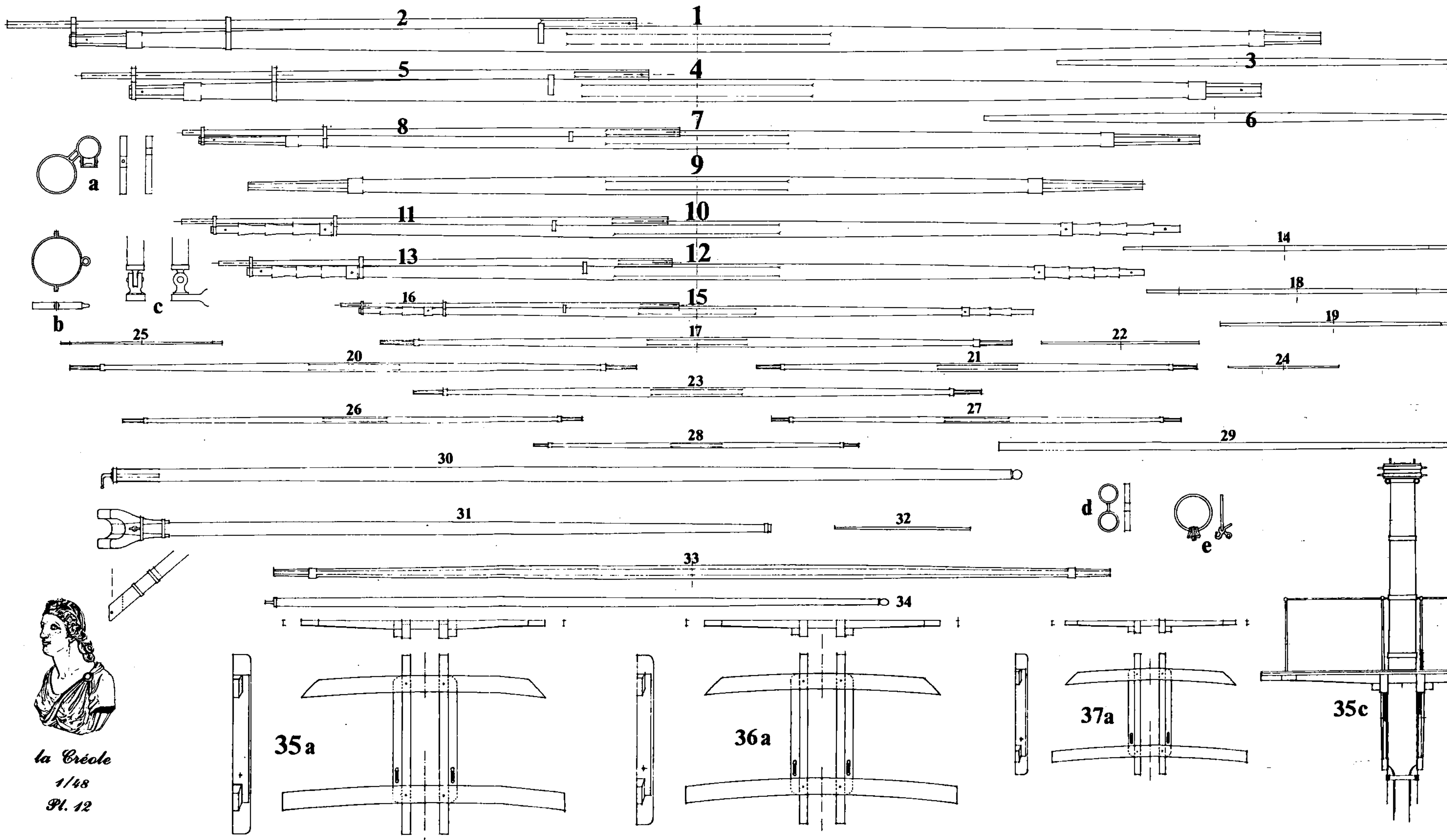

la Créele
1/48
Pl. 12

